



FIELDCOMM GROUP™

*Connecting the World of
Process Automation*

HART-IP™

**Rooted in HART®
Evolving with Ethernet**

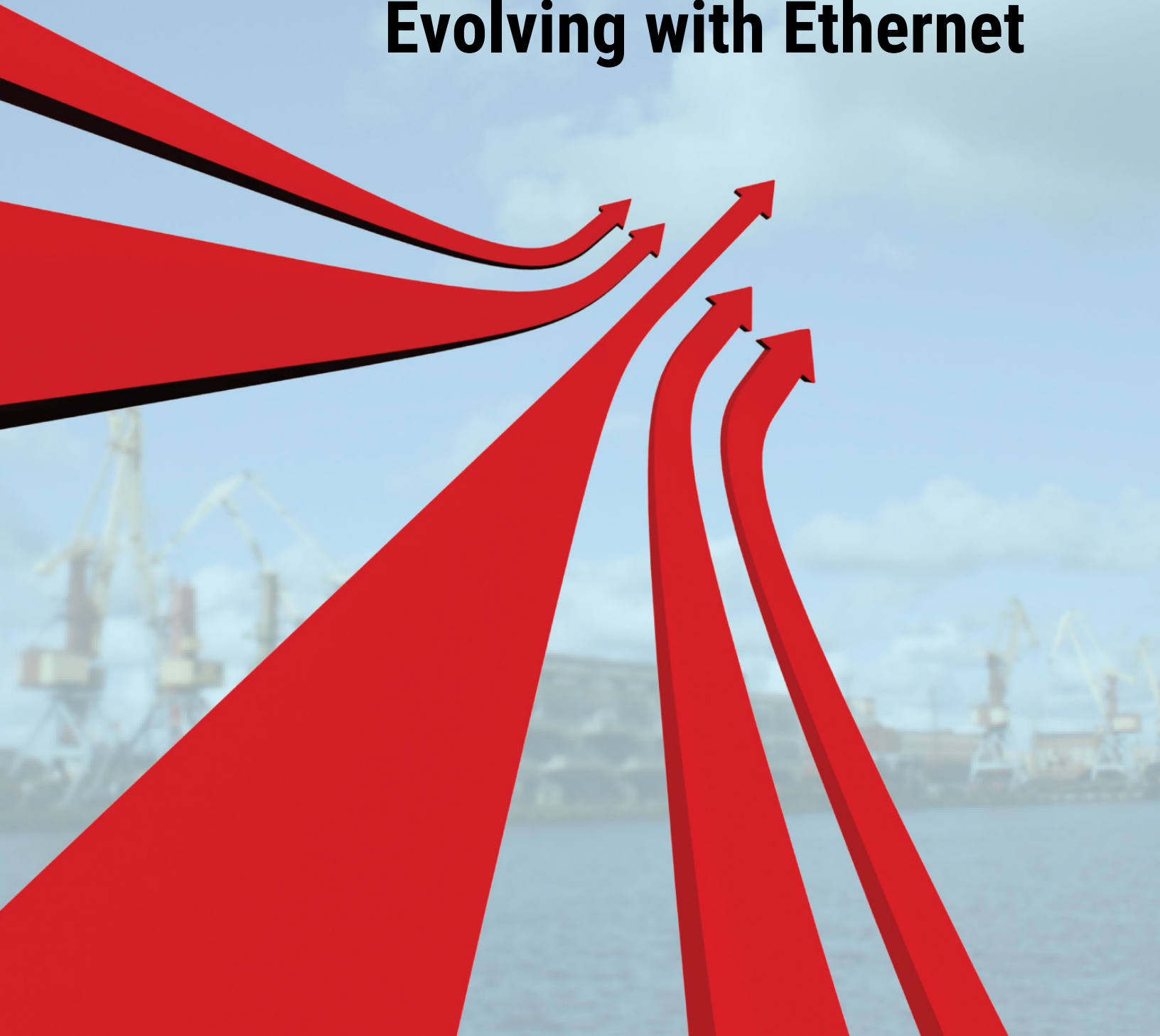

INTEROPERABLE

PROVEN

FAST

ALL DIGITAL

FAMILIAR

INTERCHANGEABLE

EASY TO USE

HART-IP™

HART-IP®: Future-Proof Evolution

HART-IP was first introduced in 2007 as a high-speed Ethernet protocol to communicate HART data collected from WirelessHART® gateways. In recent years, the utilization of HART data from existing devices has only continued to increase. For many end users, the primary use case for the 4-20mA version of HART was during device installation and commissioning, after which they turned to handheld communicators for periodic field troubleshooting and calibration. But booming interest in realizing the benefits of digital transformation has an increasing number of users seeking to continuously use more of the HART data already available in their instruments. This means that end users are only expanding their investments in the HART ecosystem.

HART FUNCTIONALITY IS NO LONGER LIMITED TO MONITORING AND DIAGNOSTICS — WITH HART-IP, CONTROL IS NOW A REALITY

HART-IP has advanced significantly since it was first introduced. Adding an integrated security model in the latest version of HART-IP in the 2020 update to the standard was key to establishing a proper cybersecurity posture on the next generation of Ethernet-based field devices. It's also important to realize that in HART-IP, the 4-20mA analog signal is replaced with a secure, high-speed digital transmission of process variables and control instructions. In short, digital HART functionality is no longer limited to monitoring and diagnostics — with HART-IP, control is now a reality. Tests performed on Ethernet-APL indicate bandwidth that is more than sufficient for closing the loop on process control applications.

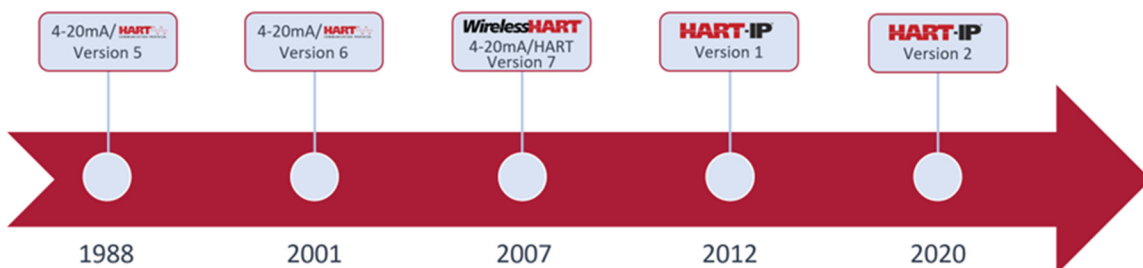

HART-IP: Rooted in HART - Ready for Ethernet-APL

HART is by far the largest digital communications technology deployed in the process industry, with millions of field instruments installed worldwide.

HART was created as a command/response protocol, in which a host issues a command and a device responds. When there are many devices in an installation and a host is communicating with many of these devices, the host needs to know the name or address of the device it wants to issue a command to. This addressing scheme is defined in the HART protocol specification. But when HART was adapted to Internet Protocol (IP) back in 2007 to backhaul data from WirelessHART gateways, the addressing scheme defined by HART was no longer required. Rather, IP-addressing is used and each device is assigned an IP address. It's as simple as that: HART-IP is the same as HART, but with IP addressing. It's the Ethernet-APL physical layer that makes it dramatically faster.

The key advantage of using HART-IP with Ethernet-APL is leveraging the existing HART command set that provides uniform and consistent communication for all HART Registered field devices regardless of the device vendor and is already supported by major process automation systems today.

The command set includes three main classes:

Universal

All devices using the HART Protocol must recognize and support the universal commands. Universal commands provide access to information useful in normal operations (e.g., read primary variable and units).

Common Practice

Common Practice commands provide functions implemented by many, but not necessarily all, HART Communication devices.

Device Specific

Device Specific commands represent functions that are unique to each field device. These commands access setup and calibration information, as well as information about the construction of the device. Information on Device Specific commands is available from device manufacturers.

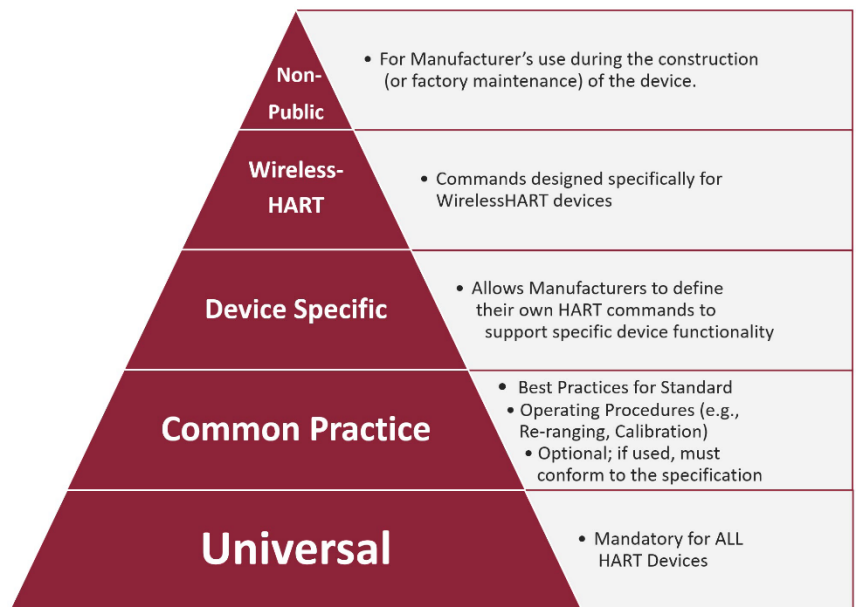

Easy to Implement

HART-IP is an application protocol which works over regular Ethernet and Ethernet-APL networks, as well as physical media that can support Ethernet, such as copper cable, fiber-optic, Power over Ethernet (PoE) and wireless links using Wi-Fi and other media supporting UDP/TCP/IP like mobile/cellular (3G/4G/LTE/5G), microwave or satellite communications.

HART-IP is fully routable and networking infrastructure does not need to be "HART-IP compatible", which means that regular industrial grade network infrastructure components or Ethernet-APL equipment, can be used. But what's even more special about HART is that the protocol remains consistent across all these architectures—Ethernet-APL, WirelessHART and 4-20mA HART. That means leveraging familiar tools and minimizing training of plant personnel on new work practices when adding Ethernet-APL to the mix.

HART-IP enables HART multiplexers, WirelessHART gateways, HART-IP Remote I/O Gateways, HART-IP enabled instruments, Safety Instrumented Systems (SIS), Integrated Device Management (IDM) software and FDI host systems from different vendors to work together with minimal effort. Analytics apps for steam traps and relief valves, corrosion, erosion and vibration connect to WirelessHART gateways directly through HART-IP without mapping through other protocols.

In a NAMUR Open Architecture (NOA) based system, a HART-IP OPC-UA server can automatically convert HART data to the Process Automation Device Information Model (PA-DIM®) without manual mapping for the “NOA Channel” pass-through.

Stand-alone logic solvers, part of independent Safety Instrumented Systems (SIS), have HART-IP pass-through of the data in underlying 4-20 mA/HART instruments. The same applies to Remote Terminal Units (RTU), flow computers, PLCs and remote-I/O supporting HART-IP.

Intelligent Device Management (IDM) software, designed for field instrument configuration/setup, diagnostics and calibration, as well as FDI hosts support HART-IP to access data through HART multiplexers, WirelessHART gateways and SIS.

Embedded Cybersecurity

Keeping your information safe and protected is critical in today’s industrial plants. The HART protocol was designed with this in mind and defense-in-depth philosophy embedded into the protocol.

Security features of HART-IP include secure provisioning, TLS/DTLS password and Pre-Shared Key (PSK), syslog support, client access level control (read, or read/write) and message encryption. These features are requirements for any HART enabled device to be certified, providing peace-of-mind that all HART communication, (HART 4-20mA, WirelessHART and HART-IP) is secure.



HART-IP devices also must support syslogging, an industry standard means of publishing device events to a network’s security information and event management (SIEM) system. All HART-IP devices must support network time using either Network Time Protocol (NTP) or Precision Time Protocol (PTP). Consequently, all syslog messages from all network devices are time synchronized, enabling forensics on network-wide behavior and activities. Combining communication security, audit logs and syslogging results in robust security for HART-IP enabled products.

Cloud Ready

Since HART-IP is based on IP it also runs across the enterprise network and the Internet straight into HART-IP compliant analytics and applications running in the cloud without conversion to other messaging protocols thus avoiding loss of semantics associated with data mapping. This makes designing for the Industrial Internet of Things (IIoT), cloud computing and connected services business models very easy.



IT/OT integration is easy and IT/OT collaboration is smooth. Nevertheless, an edge gateway can be used for conversion of HART-IP to OPC-UA, MQTT, or other protocol for platforms or software that does not have native support for HART-IP.

HART-IP Benefits

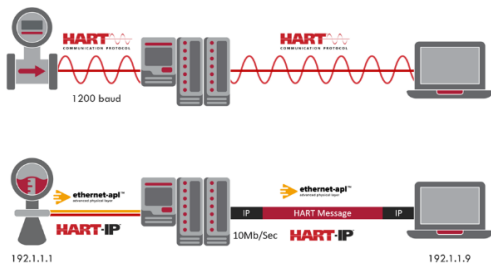

It's FAST

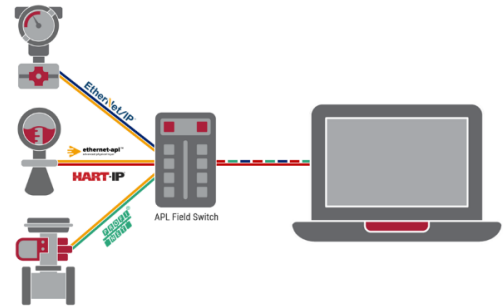

It's FLEXIBLE

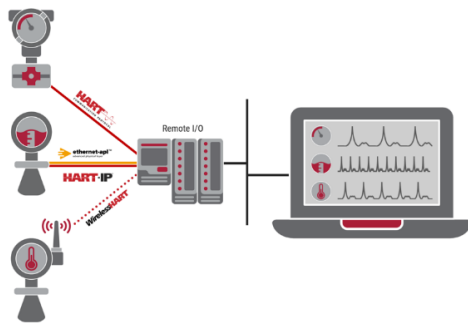

It's SEAMLESS

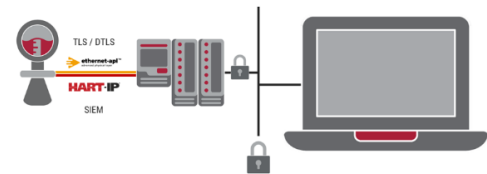

It's SECURE



It's FAST

At 10Mb/Sec HART-IP with Ethernet-APL can transfer a 1MB file in about one second. With HART 4-20mA, this same file transfer would take 2 hours and 25 minutes! It's fast!

It's FLEXIBLE

Since Ethernet-APL does not rely on application layer specific protocols, any instrument that supports the Ethernet-APL physical layer may be connected to Ethernet-APL switches. This includes other process automation protocols, as well as new IP enabled devices - thermal imagers, for example.

It's SEAMLESS

Adding HART-IP instruments to an existing HART installation is seamless. Existing software, existing work practices and existing configuration tools will be the same familiar HART tools that are already commonplace in facilities.

It's SECURE

HART-IP has always required security, but with the 2020 release of the HART specification, the specific types of security features that must be implemented are now specified. Support for TLS, DTLS, syslog and audit logs are now all required for conformance in HART-IP devices.

Transitioning to HART-IP

If your plant has 4-20mA/HART and WirelessHART devices, then it is possible that HART-IP is already being used to pass data between gateways, multiplexers, control system I/O and device management software.

As Ethernet-APL instruments become available, they can be connected to the area control network via HART-IP through a simple Ethernet-APL field switch. And as confidence grows, an Ethernet-APL power switch can be added to bring power and communications to multiple field switches that power many instruments, including new instrument types like video cameras or thermal imaging systems.

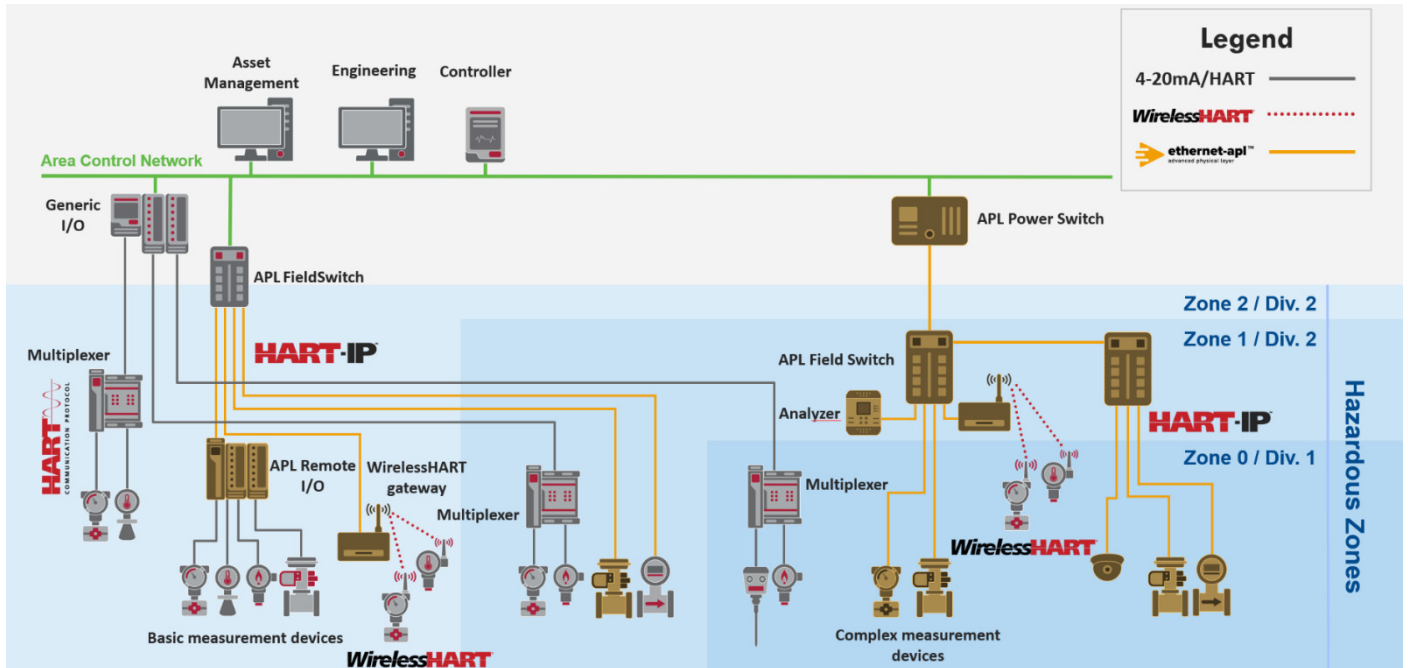

Summary



HART-IP is a simple-to-use, high-level application technology that is independent of the underlying physical layer. HART-IP operates with Ethernet as well as mesh or ring topologies. Similarly, HART-IP can run on Power over Ethernet (PoE) for such infrastructure and devices.

It's fast, flexible, seamless and secure.

Evolving HART technology, as we move toward a digital future, allows users to preserve what has become industry's best example of ecosystem interoperability among different process automation suppliers' devices and systems.

About FieldComm Group

FieldComm Group is a global standards-based non-profit member organization consisting of leading process end users, manufacturers, universities and research organizations that work together to direct the development, incorporation and implementation of communication technologies for the process industries. Membership is open to anyone interested in the use of the technologies. In addition to HART and FOUNDATION Fieldbus communication technologies, FieldComm Group is responsible for ongoing development of Field Device Integration (FDI) Technology.

The establishment of the FieldComm Group allows developers of digital open standards to better collaborate on new and existing technologies and to increase market share of digital field devices in the total device market.



Mission:

- Develop, manage and promote global standards for integrating digital devices to on-site, mobile and cloud-based systems
- Provide services for standards conformance and implementation of process automation devices and systems that enable and improve reliability and multi-vendor interoperability
- Lead the development of a unified information model of process automation field devices while building upon industry investment in the HART®, FOUNDATION™ Fieldbus and FDI™ standards

Attend an Event

FieldComm Group participates in many global seminars, exhibitions and user group events covering all our technologies and applications. Whether you are located in North or South America, Europe, Middle East, Africa or Asia, you can always find an event near you. Visit fieldcommgroup.org/events to see where we will be next!

Become a Member - Gain the Competitive Edge

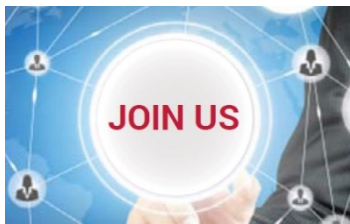

FieldComm Group offers a significant number of benefits through membership. Whether you are a manufacturer, systems integrator, educational institution, end user or other professional in the business, FieldComm Group helps you gain the competitive edge through open interoperable standards supporting the digital transformation of industry.

Learn more by visiting go.fieldcommgroup.org/membership

Get Trained

For organizations desiring to position themselves as leaders in their competitive field, their personnel must be trained to take advantage of the latest technology capabilities. Certified end user training is offered at prestigious training facilities around the world to ensure your staff are trained on the leading edge of our technologies. Through this program, training facilities, curriculum and instructors are audited to ensure they meet stringent program requirements for vendor neutrality and up-to-date competency. Learn more by visiting the Education section of fieldcommgroup.org.

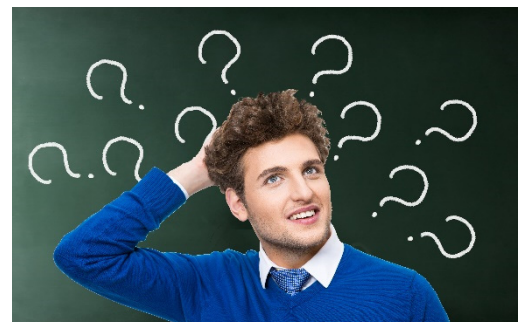



FIELD COMM GROUP™

*Connecting the World of
Process Automation*

FieldComm Group

9430 Research Blvd., Ste 1-120

Austin, TX 78759 USA

info@fieldcommgroup.org

+1 512.792.2300

fieldcommgroup.org